

Z-Condensor®

DIRECTIONS FOR USE

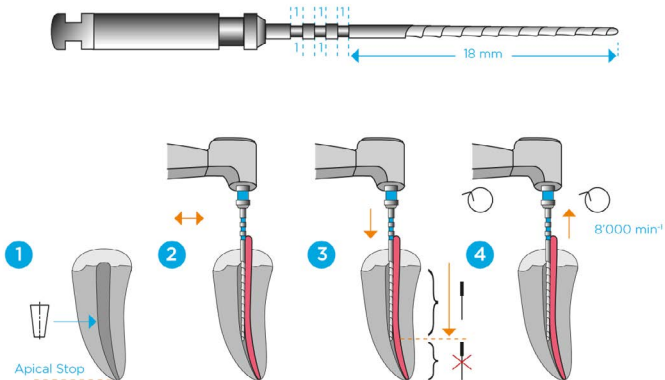

COMPOSITION

The cutting surface of these instruments is made of a nickel-titanium alloy.

1) INDICATIONS FOR USE

These instruments have been designed to be used exclusively in a dental clinic or hospital setting by qualified users.

Application field: Z-Condensor® is a dental instrument for root canals used to mechanically condense gutta-percha in the root canal after instrumentation, cleaning and disinfection is complete.

2) CONTRAINDICATIONS

- As with all mechanically driven root canal instruments, Z-Condensor® files should not be used in cases of severe and sudden apical curvatures due to heightened risk of separation.
- Z-Condensor® is not recommended for use in patients with a known allergy to nickel. The use of this product in these patients may cause: difficulty breathing, swelling of the face or eyes, hives or rash. If any of these symptoms occur, patients should be advised to contact a dental professional immediately.



3) WARNINGS

- The use of Z-Condensor® is not risk-free. The main danger is a possible penetration of the gutta-percha into the periapical region. The following reasons may be responsible for this: the use of a too-small or too-fine master cone, a too-small Z-Condensor®, excessive speed or axial pressure, or a too-deep insertion of the Z-Condensor® into the root canal. Even a small amount of gutta-percha in the periapical region can cause severe clinical reactions. There is no resorption to be expected from the periapical macrophages.
- In the case of multicuspid mandibular teeth, an overfilling reaching the inferior dental nerve can provoke irreversible damage, such as dysesthesia, paresthesia, anaesthesia, or paralysis with a possible labiodynisis.
- The files are single-use only, so they are not to be reused as this can cause deformation defects (bending, stretching), fractures, corrosion, loss of colour or markings identification, etc., which would mean the instruments cannot meet the level of safety required for the intended use.
- Reuse increases the risk of cross-contamination and breakage.
- There is an increased risk of file separation when used after several disinfection or sterilisation cycles.

4) PRECAUTIONS FOR USE

- Never use the Z-Condensor® in anticlockwise rotation (danger of getting stuck in the canal or bone).
- Do not penetrate the tip of the instrument into the canal to a distance of less than 2 mm from the apex.
- Do not oppose strong resistance when the Z-Condensor® is backing out of the canal.

5) ADVERSE REACTIONS

- In the case of multicuspid mandibular teeth, an overfilling reaching the inferior dental nerve can provoke irreversible damage, such as dysesthesia, paresthesia, anaesthesia, or paralysis with a possible labiodynisis.
- Z-Condensor® is not recommended for use in patients with a known allergy to nickel. The use of this product in these patients may cause: difficulty breathing, swelling of the face or eyes, hives or rash. If any of these symptoms occur, patients should be advised to contact a dental professional immediately.

6) STEP-BY-STEP INSTRUCTIONS FOR USE OF Z-Condensor® FILES

Z-Condensor® is a NiTi instrument. The rotation of this instrument against the gutta-percha plastifies this material by heat produced by friction. In this plastic state, the gutta-percha advances apically and condenses.

In order to obtain sufficient heat to plastify the gutta-percha, the Z-Condensor® must be used at a low speed with a high torque instrument capable of rotating at a low speed 8'000 min⁻¹ with a high torque. For a complete obturation of the root canal system, bring the instrument to a distance of 2 mm from the apex of the canal which has already been prepared. The penetration depth of the Z-Condensor® can be checked using the graduations marked on the shaft of the instrument or by using a silicone stopper.

- 1) Establish the working length and apical stop of the root canal.
- 2) Insert the gutta-percha point and the Z-Condensor® into the canal, and press the Z-Condensor® against the gutta-percha.



- 3) Descend the Z-Condensor® into the canal, rotating clockwise at 8'000 min-1.
Do not penetrate Z-Condensor® to a distance of less than 2 mm from the apex.
- 4) Back the Z-Condensor® out of the canal, without opposing strong resistance.

7) CLEANING, DISINFECTION AND STERILISATION

Dental instrument reprocessing procedure.

I - FOREWORD

Instruments marked “sterile” do not require any specific treatment before first use. For the rest of the instruments that are not marked “sterile”, cleaning and sterilisation is necessary before using them for the first time in accordance with section III - STEP-BY-STEP INSTRUCTIONS of these directions for use.

Excluded devices:

Uniclip and Mooser calcinable plastic posts cannot be sterilised and must be disinfected by immersion in NaOCl (2.5 % at least) during 5 minutes at ambient temperature.

II - GENERAL RECOMMENDATIONS

- 1) Use only a detergent solution with a disinfectant action approved for its effectiveness (VAH/DGHM-listing, CE marking, FDA approval) and follow the instructions of the manufacturer of said product. Anticorrosive cleaning products and disinfectants are recommended for all metal instruments.
- 2) For your own safety, please use personal protective equipment (gloves, goggles and mask).
- 3) The user is responsible for the cleaning and sterilisation of the product for the first cycle and each subsequent use, as well as the use of dirty or damaged instruments after sterilisation.
- 4) The safest option for the professional is to use our instruments only once. After each use, they must be thoroughly inspected before being used again; the presence of defects such as deformations (bent, stretched), fractures, corrosion, loss of colour identification, marking, etc. are indications that the instruments cannot meet the level of safety required for their intended use and should therefore be discarded.
- 5) Instruments marked as single-use only are not approved for reuse.
- 6) For the final rinse it is mandatory to use deionised water, either using an automatic washer-disinfector or a manual cleaning method. For the other rinsing steps tap water use is allowed.
- 7) Instruments with plastic handles, and NiTi instruments should not be used with Hydrogen Peroxide (H₂O₂) solution which is known to degrade them.
- 8) Only the active part of the NiTi instrument that is in contact with the patient should be immersed in a NaOCl solution with a concentration NOT greater than 5%.
- 9) Prevent the instrument from drying out before or during pre-disinfection or cleaning. Dried biological material can be difficult to remove.
- 10) Do not place identifying labels or markers directly on the instrument.



III- STEP-BY-STEP INSTRUCTIONS

Operation		Description and Warnings
1	Disassembling	<ul style="list-style-type: none"> Remove and discard the silicone stoppers.
2	Rinsing	<ul style="list-style-type: none"> Rinse abundantly (for at least 1 minute) under running water at ambient temperature. While rinsing, use a soft brush (nylon, polypropylene, acrylic) for pre-cleaning until visible impurities are removed.
3a	Automated cleaning with washer-disinfector	<ul style="list-style-type: none"> Place the instrument in a kit, support, or container made of stainless steel or titanium. Execute the defined cycle with detergent solution (for example, Metrex EmPowder concentration 1:128 - 1:512) for at least 5 minutes in the washer-disinfector at 20°C - 40°C).
3b.I	Manual cleaning assisted by an ultrasonic device	<ul style="list-style-type: none"> Place the instrument in a kit, support, or container made of stainless steel, polypropylene, or titanium. Submerge it in a detergent solution (for example, Metrex EmPowder concentration 1:128) with cleaning properties. If applicable, soak it for at least 15 minutes with the help of an ultrasonic device. Rinsing: perform a long rinse (at least 1 minute) under running deionised water at a temperature of 20°C - 40°C. Drying: dry with a single-use non-woven cloth or with a hot air dryer no hotter than 110°C.
3b.II	Manual disinfection with washer-disinfector	<ul style="list-style-type: none"> Place the instrument in a kit, support, or container made of stainless steel or titanium. Execute the defined cycle with a mild neutral enzymatic cleaning agent solution (for example, Metrex EmPowder concentration 1:128) for at least 5 minutes in the washer-disinfector at a temperature of >90°C, A0 >3000. Note: <ol style="list-style-type: none"> Discard instruments with obvious defects (broken, bent, etc.). When the instruments are placed in a cleaning kit, support, or container, avoid any contact between them. Follow instructions and concentrations given by the manufacturer of the detergent solution (see also general recommendations). Follow the instructions of the washer-disinfector and verify the success criteria after each cycle have been met as stated by the manufacture. The final rinse step should be with deionised water. For other steps follow the water quality defined by the manufacturer. Place the instrument in a kit, support, or container made of stainless steel or titanium to avoid any contact between devices or posts.



Operation		Description and Warnings
3b.III	Rinsing	<ul style="list-style-type: none"> • Rinse abundantly (for at least 1 minute) under running water at ambient temperature. • Use deionised water for rinsing. • If the previously used cleaning solution contains a corrosion inhibitor, rinsing is recommended just before autoclaving.
3b.IV	Drying	<p>Devices should be carefully dried before inspection and packaging</p> <ul style="list-style-type: none"> • Dry with a single-use non-woven cloth or with a hot air dryer at a maximum temperature of 110 °C. • The devices should be dried until visual traces of moisture are eliminated. • Particular attention has to be paid to effectively dry joints or cavities inside the device.
4	Inspection	<ul style="list-style-type: none"> • Inspect the operation of the devices. • Inspect devices and identify those with defects. <p>1) Dirty devices need to be cleaned again. 2) Do not reuse the silicone stoppers. 3) Dispose of any defective devices.</p>
5	Packaging	<p>Place the devices in a kit, support or container to avoid any contact between instruments or posts and pack the devices in “Sterilisation Pouches”. (Use packaging that is resistant to a temperature of 141 °C (286 °F) and that is UNE-EN ISO 11607 compliant).</p> <p>1) Avoid any contact between instruments or posts during sterilisation. Use kits, supports or containers. 2) For sharp devices not contained within a box, silicone tubing should be placed around the devices to prevent puncture of the packaging. 3) Seal pouches per the pouch manufacturer’s recommendation. If a thermo-sealer is used, the process must be validated. 4) Check the expiry date of the pouch indicated by the pouch manufacturer to determine the shelf life of the sterile product.</p>
6	Sterilisation	<ul style="list-style-type: none"> • For these devices, steam sterilisation is recommended at 132°C / 273°F for 4 minutes, for the purpose of de-activating potential prions. • Instruments and posts must be sterilised according to the package labelling. • Place pouches in steam steriliser per steriliser manufacturer’s recommendation. • Use only steam sterilisers that meet the requirements of EN 13060 (class B, small steriliser), EN 285 (full size steriliser). • Use a validated sterilisation procedure according to ISO 17665 with a minimum drying time of 20 minutes.



Operación		Descripción y advertencias
6	Sterilisation	<ul style="list-style-type: none"> Follow the steriliser maintenance procedure indicated by the steriliser manufacturer. Control the efficiency and the acceptance criteria of the sterilisation procedure (packaging integrity, no humidity, no colour change of the packaging, positive physicochemical indicators, conformity of actual cycle parameters to reference cycle parameters). Store traceability records and define shelf life according to packaging manufacturer guidelines. Shorter sterilisation cycles according to local regulations are possible but are not guaranteed to de-activate prions.
7	Storage	<p>Keep devices in sterilised packaging in a clean environment, away from sources of moisture and direct sunlight. Store at ambient temperature.</p> <p>1) Sterility cannot be guaranteed if the packaging is open, damaged or wet. 2) Check the packaging and medical devices before use (integrity of the packaging, absence of humidity and expiry date).</p>

8) TRANSPORT

- To prevent the medical device from being damaged during transport, the use of specific racks, trays or rigid containers may be recommended.
- When the package is broken, it is no longer sterile. It must be cleaned, disinfected and sterilised before use.

9) STORAGE AND EXPIRY

- Avoid storing in places with high temperatures, humidity and/or direct sunlight. Keep liquids away. Store at ambient temperature.
- Do not damage or puncture the packaging materials.
- This product is subject to improvement without prior notice. Apply the “first in, first out” approach to inventory management.
- Do not store under a germicidal lamp to prevent deterioration.
- The shelf life of endodontic files is 5 years.

10) DISPOSAL



















- This product should be disposed of as medical waste.
- For correct disposal, always respect national laws and recommendations from authorities.

11) PACKAGING

- Minimum packaging unit: 4pcs/pack in aluminium foil box.



12) IDENTIFICATION OF RELATED SYMBOLS

Symbols	Identification
 FOR DENTAL USE ONLY	Product designated for dental use only
	Do not reuse – Single-use only
	Workpiece Material: Nickel Titanium
	Rotating handle
	Medical Device
Heat activation	Pre-bendable
 XXXXX – XXXXX min ⁻¹	Recommended rotation speed
 XXX mNm	Recommended torque for use
	Batch number
	Sterilised by radiation
	Reference number
	Expiry date
	Consult directions for use
	Authorized representative in the EU
	Manufacturer
	Autoclavable at the specified temperature
	Non-returnable if the seal is broken
	Stopper material: silicone
	Do not use if packaging is damaged. Consult directions for use.
	CE marking



Shenzhen Denco Medical Co., Ltd
Room 3108, Block 6, Tian'an Cloud Park,
Bantian street, Longgang District,
Shenzhen, 518129, P.R. China



Share Info GmbH
Am Schulzentrum 12,
41564 Kaarst, Germany



Wellkang Ltd
16 Castle St., Dover, Kent,
CT16 1PW, England



Omologic, Homologación y Mercado CE, S.L.U.
Calle Santa Rosalía 21, Escalera 2, 1ºB,
18007 Granada (Spain)